

REV	ECN NO	DESCRIPTION	DATE	APPD
X1		INITIAL EDITION	2013.02.18	Ford Liu

A3

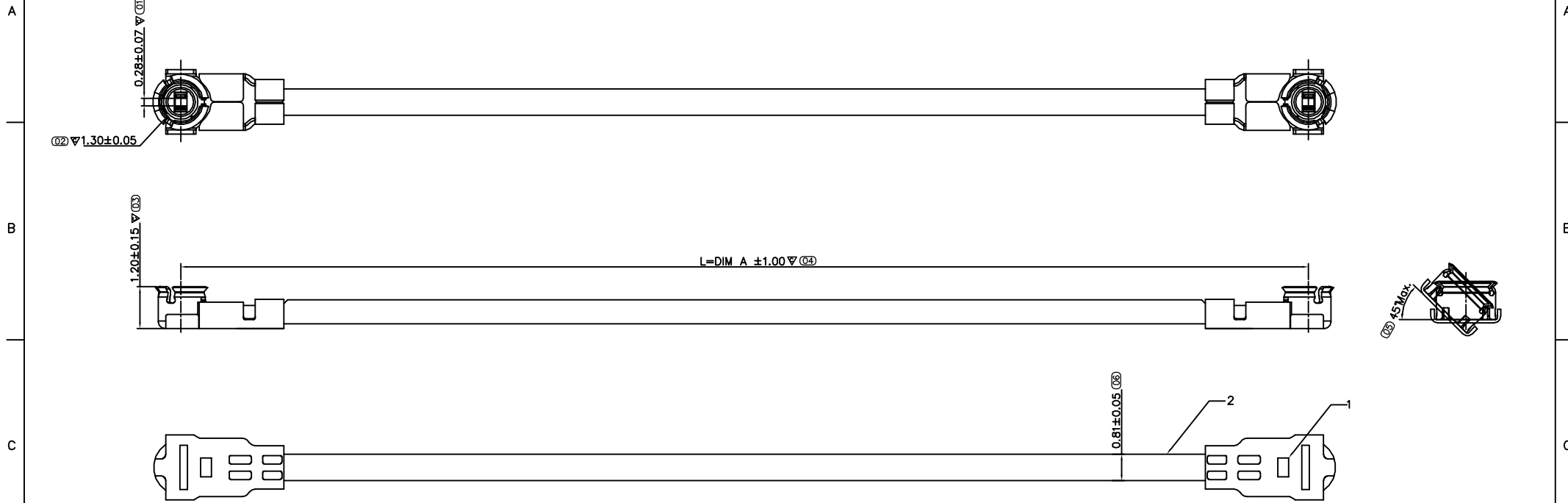

2		1	CABLE(Ø0.81,Colour:BLACK)
1	7.015A1-000-1R0	2	RF 1.5H CONNECTOR PLUG
ITEM	PART NO.	Q'TY	DESCRIPTION
BOM LIST			

7.018AJ-933-1B0	93.3
P/N	DIM A

Note:

1. Technology Parameter
 - 1.1 Voltage Rating: 60VAC(R.M.S)
 - 1.2 Frequency Rating: DC0.1~6G Hz
 - 1.3 Nominal Characteristic Impedance: 50 ohms
 - 1.4 Operating Temperature Range: -40°C~+85°C
 - 1.5 Operating Humidity: 95%R.H.MAX
2. Electric Performance
 - 2.1 Insulation Resistance: 500M ohms
 - 2.2 Contact Resistance
 - 2.2.1 Inner Contact: 25 mohms Max.
 - 2.2.2 Outer Contact: 25 mohms Max.
 - 2.3 Withstand Voltage: 200V AC 1minute
 - 2.4 VSWR:
 - 1.3 Max. DC0.1~3G Hz
 - 0.5dB Max. 500M~1.2G Hz
 - 1.2dB Max. 1.5G~2.3G Hz
3. Mechanism Performance
 - 3.1 Durability: 30 Cycles
4. All the material followed the ROHS standard

EXTEND USE		RF 1.5H CONNECTOR PLUG+CABLE		UNIT mm		TITLE		7.018AJ CONNECTOR CUSTOMER DRAWING			
GENERAL TOLERANCE (D)		MATERIAL		APPD		Ford Liu		2013.02.18		DWG NO	
DIMENSION		ANGLES		QTY		CHD		Erich Zheng		P/N:	
.0 ±0.30		.0 ±3°				DRN		Charles Yang		C-7.018AJ	
.0 ±0.25		.0 ±2°						2013.02.18		(SEE NOTE)	
.00 ±0.20		.00 ±1°								SHEET	
.000 ±0.10										SCALE	
										1/1	
										REV	
										X1	

A3

REV	ECN NO	DESCRIPTION	DATE	APPD
X1		INITIAL EDITION	2013.02.18	Ford Liu

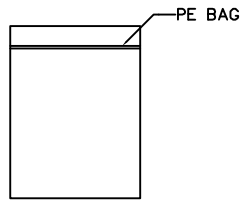

↓ 20PCS

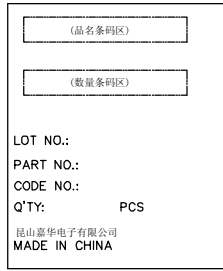

LABLE-INNER BOX

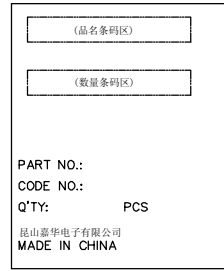

LABLE-CARTON

BOM:

P/N	Q' TY		
	PE BAG	INNER BOX	CARTON
7.018AJ-933-1B0	100PCS	2000PCS	8000PCS

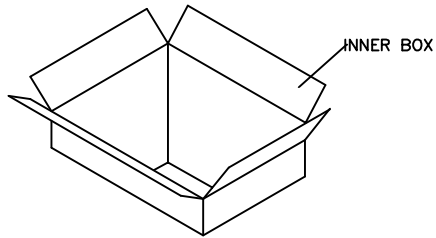

↓

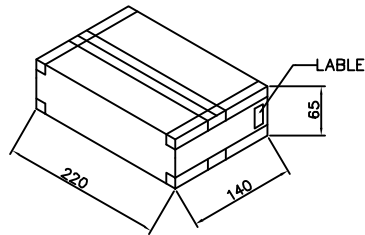

→ 4PCS

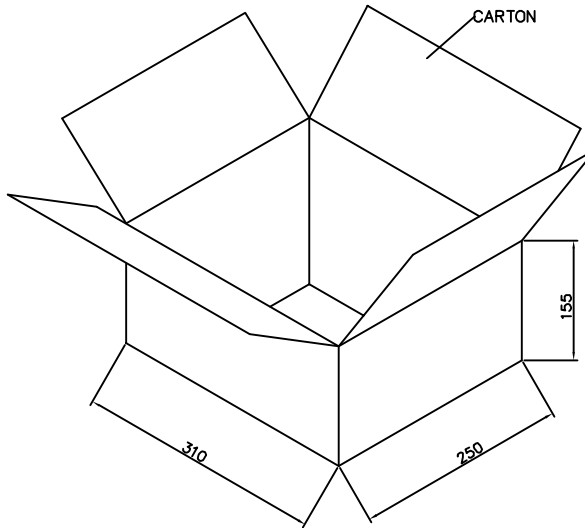

→

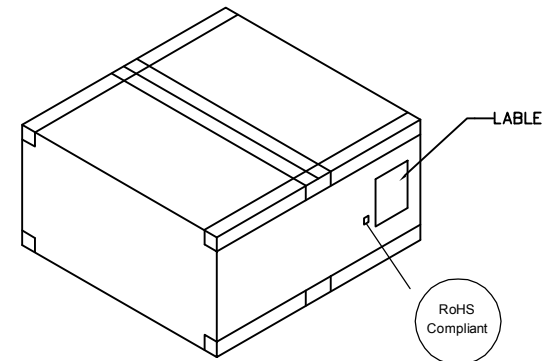

EXTEND USE		TITLE		F.A.F.	
RF 1.5H CONNECTOR PLUG+CABLE		UNIT	7.018AJ CONNECTOR CUSTOMER DRAWING	DWG NO	
GENERAL TOLERANCE		MATERIAL	APPD	C-7.018AJ	
DIMENSION		QTY	CHD	P/N:	
ANGLES		FINISHED	DRN	(SEE TAB)	
. ±0.30	. ±3°		Charles Yang 2013.02.18	SHEET	SCALE
.0 ±0.25	.0 ±2°			1/1	1:1
.00 ±0.20	.00 ±1°			REV	X1
.000 ±0.10					